

Flow-through cell

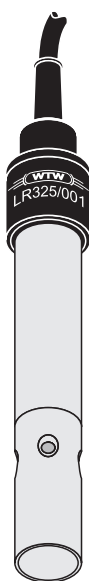

Immersion cell

LR 325/001

ULTRAPURE WATER CONDUCTIVITY MEASURING CELL

LR 325/001 - Contents

1	Overview	4
1.1	Structure and function	4
1.2	Recommended fields of application	4
2	Installation	5
2.1	Changing between flow-through cell and immersion cell	5
2.2	Use as flow-through cell	5
3	Cleaning	6
4	What to do if...	6
5	Technical data	7

1 Overview

1.1 Structure and function

Structure

Flow-through cell:

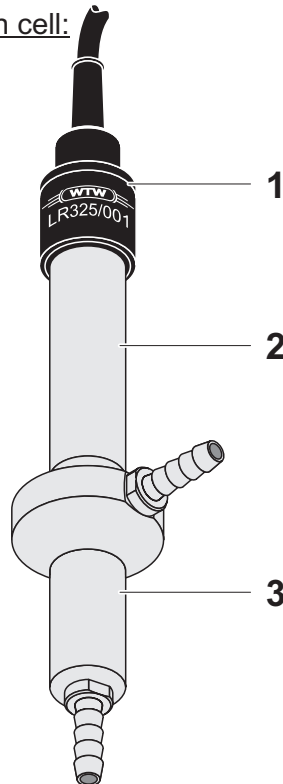

Immersion cell:

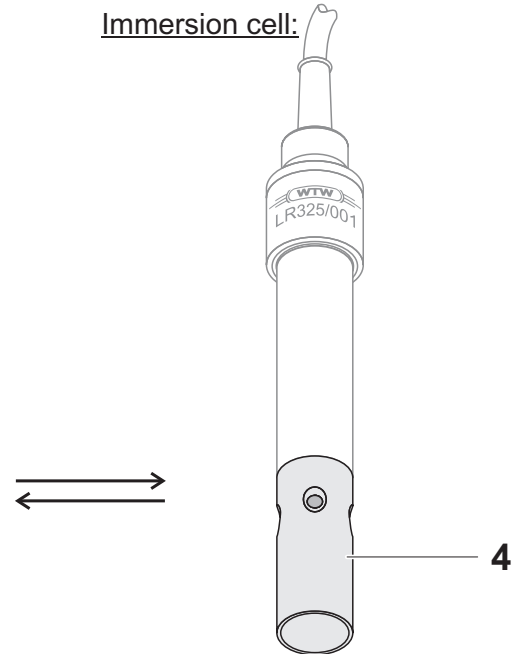

1	Connection head
2	Shaft with inside electrode and temperature sensor
3	Outside electrode of the flow-through cell
4	Outside electrode of the immersion cell

1.2 Recommended fields of application

Measurements in ultrapure water in flow-through or immersion operation, depending on the mounted outside electrode.

2 Installation

2.1 Changing between flow-through cell and immersion cell

The outside electrode is connected to the shaft via a screw connection and can be removed and replaced as necessary without using any tools. When mounting the electrode tighten the screw connection by hand as far as it will go.

2.2 Use as flow-through cell

To avoid the collection of air bubbles in the electrode area, the flow-through cell should be positioned so that the outlet opening is at the highest point. An incline of the sensor by up to 60° supports the removal of air bubbles (see following figure).

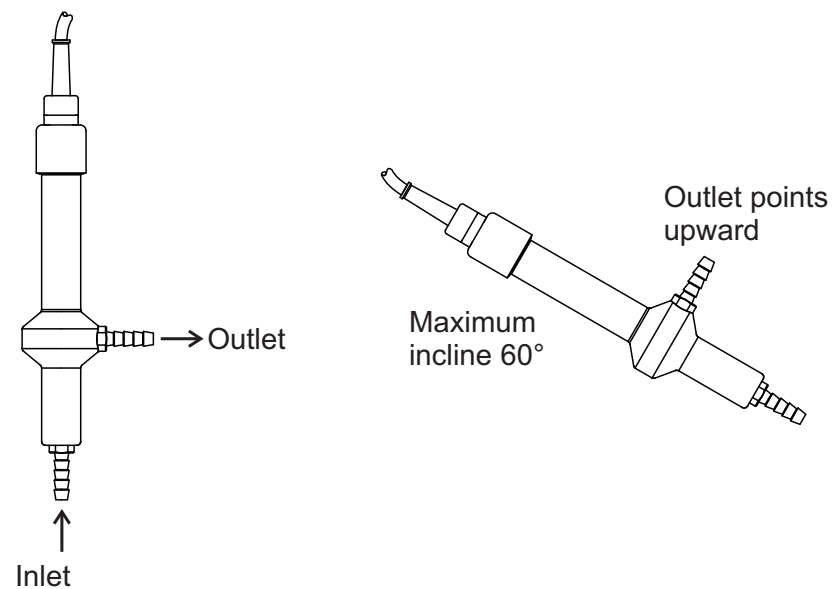

3 Cleaning



CAUTION

Prior to cleaning, disconnect the sensor from the meter.

Outside cleaning

We recommend to clean the sensor thoroughly, especially prior to measuring low conductivity values. If necessary, unscrew the outside electrode from the shaft.

Contamination	Cleaning procedure
Lime sediments	Immerse in acetic acid for 5 minutes (volume share = 10 %)
Fat/oil	Clean with warm water that contains washing-up liquid

After cleaning, thoroughly rinse with deionized water and recalibrate if necessary.

Aging of the conductivity measuring cell

Normally, the conductivity measuring cell does not age. Special measuring media (e.g. strong acids and lyes, organic solvents) or too high temperatures shorten the operational lifetime considerably or damage the measuring cell. The warranty does not cover cases where such conditions cause failure or mechanical damage.

4 What to do if...

Error symptom	Cause	Remedy
No temperature or conductivity display	<ul style="list-style-type: none"> - Connection meter - conductivity measuring cell interrupted - Cable defective 	<ul style="list-style-type: none"> - Check connection meter - conductivity measuring cell
Measurement delivers implausible conductivity values	<ul style="list-style-type: none"> - Cell constant incorrectly set at the measuring instrument - Measuring range exceeded - Outside electrode not completely screwed on - Dirt in electrode area - Air bubbles in electrode area - Electrodes damaged 	<ul style="list-style-type: none"> - Check / correct the setting - Observe the application range - Tighten outside electrode by hand as far as it will go - Clean the conductivity measuring cell (see Abschnitt 3). - Remove air bubbles by knocking laterally - Return the sensor
Incorrect temperature display	<ul style="list-style-type: none"> - The temperature sensor is not immersed deep enough in the measuring solution - Temperature sensor defective 	<ul style="list-style-type: none"> - Observe the minimum immersion depth - Return conductivity measuring cell

5 Technical data

General features

Measuring principle	Two-electrode measurement
Cell constant	0.0100 cm ⁻¹ ±2 %
Temperature sensor	integrated NTC 30 (30 kΩ at 25 °C / 77 °F)

**Dimensions
(in mm)**

Immersion cell:

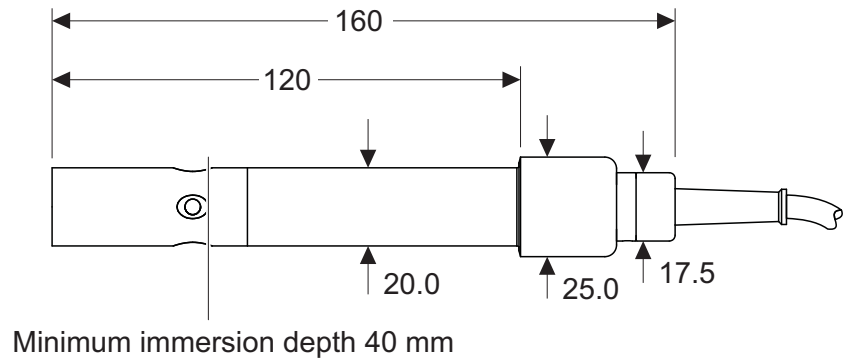

Flow-through cell:

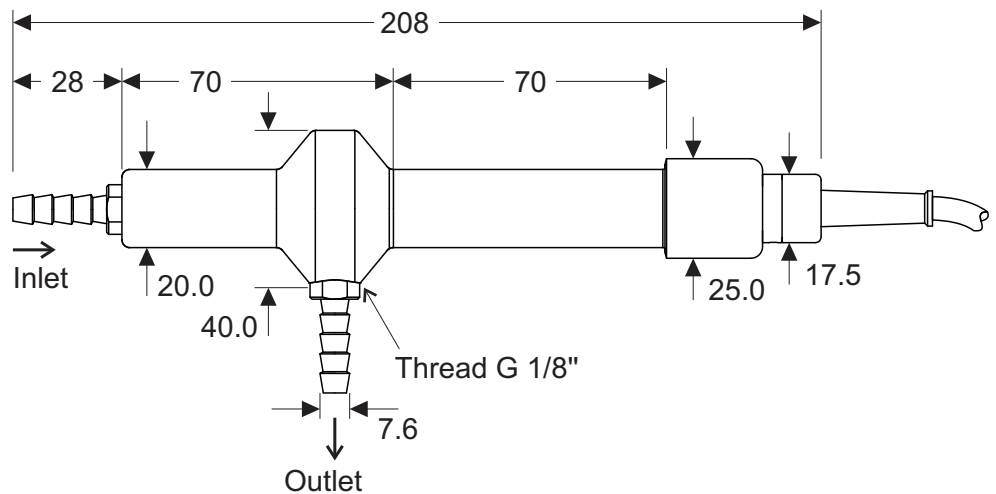

Weight (with connection cable)

Immersion cell	277 g
Flow-through cell	487 g

Materials

Shaft	Stainless steel 1.4571
Connection head with cable gland	POM
Inside electrode / temperature sensor	Stainless steel 1.4571
Insulator	POM

	Outside electrodes, hose nozzles	Stainless steel 1.4571
	Cable	PUR
	Seals	NBR
Connection cable	Length	1.5 m
	Diameter	6 mm
	Smallest allowed bend radius	fixed installation: 50 mm flexible use: 80 mm
	Plug type	Socket, 8 pins
Pressure resistance	Sensor with connection cable	IP 68 (2 x 10 ⁵ Pa or 2 bar)
	Cable plug	IP 67 (when plugged in)
The LR 325/001 meets the requirements according to article 3(3) of the 97/23/EC directive ("Pressure equipment directive").		
Measurement conditions	Conductivity measuring range	0.0001 µS/cm ... 30 µS/cm The measuring range may be limited by the meter that is used (see measuring range of your meter).
	Temperature range	-5 ... 80 °C (100 °C) / 23 ... 176 °F (212 °F)
	Max. allowed overpressure	2 x 10 ⁵ Pa (2 bar)
	Minimum immersion depth in immersion cell operation	40 mm
	Maximum immersion depth (at temperature)	Total sensor+cable (up to 80 °C / 176 °F) Sensor shaft only = 120 mm (up to 100 °C / 212 °F)
	Operating position	Immersion cell: Any Flow-through cell: Vertical or inclined by up to approx. 60°, inlet pointing downward
	Storage conditions	Recommended storing method
Storage temperature		0 ... 50 °C (32 ... 122 °F)
Characteristic data on delivery	Temperature responding behavior	t ₉₉ (99 % of the final value display after) < 100 s
	Precision of the temperature sensor	± 0.2 K

Pin-assignment

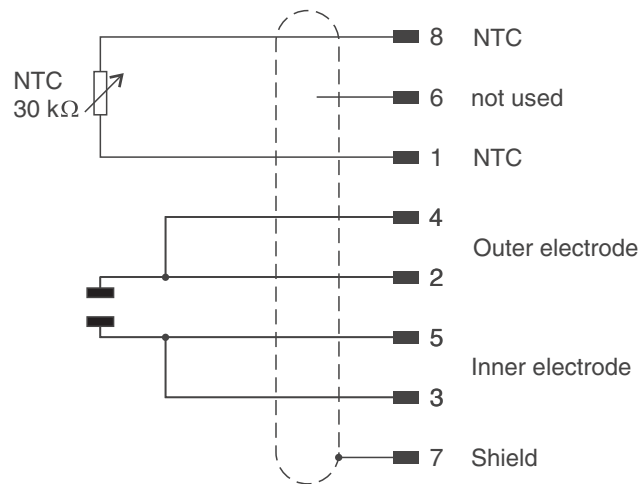

Plug from the front:

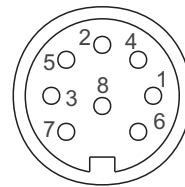

What can Xylem do for you?

We're a global team unified in a common purpose: creating innovative solutions to meet our world's water needs. Developing new technologies that will improve the way water is used, conserved, and re-used in the future is central to our work. We move, treat, analyze, and return water to the environment, and we help people use water efficiently, in their homes, buildings, factories and farms. In more than 150 countries, we have strong, long-standing relationships with customers who know us for our powerful combination of leading product brands and applications expertise, backed by a legacy of innovation.

For more information on how Xylem can help you, go to xylem.com.



Service address:

Xylem Analytics Germany
Sales GmbH & Co. KG
WTW
Dr.-Karl-Slevogt-Str. 1
82362 Weilheim
Germany

Tel.: +49 881 183-325
Fax: +49 881 183-414
E-Mail wtw.rma@xylem.com
Internet: www.WTW.com



Xylem Analytics Germany GmbH
Dr.-Karl-Slevogt-Str. 1
82362 Weilheim
Germany