

# Coupling dimensions, reduced bore ball valves DN 15–800 with actuators

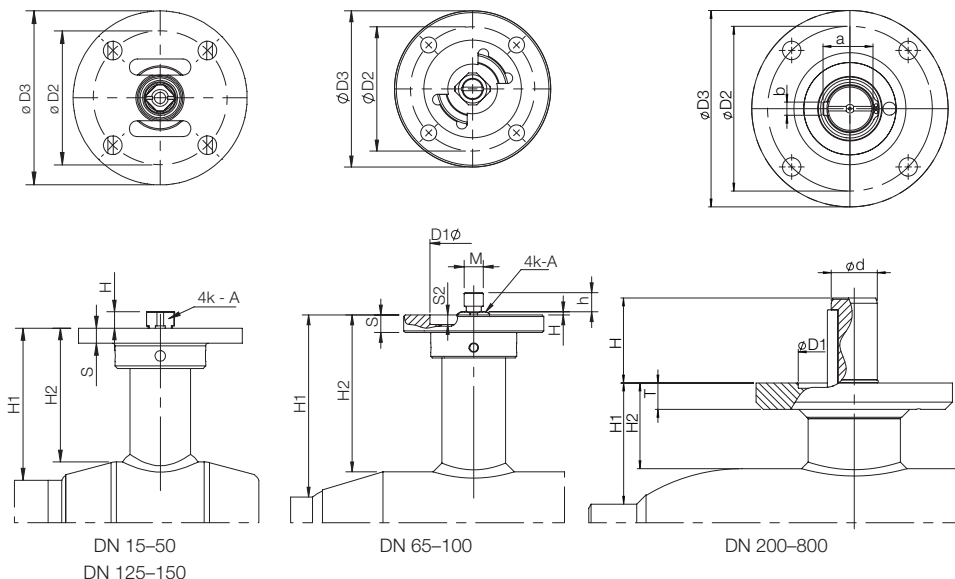

DN	H	h	S	S2	A	M	Ød	T	H1	H2	a	b	D1	D2	D3	Bolts	Key	Flange ISO5211
10	4,5		6		7				29	21				50	64	4xM6		F05
15	4,5		6		7				27	21				50	64	4xM6		F05
20	4,5		6		7				27	21				50	64	4xM6		F05
25	4,5		6		9				39	32				50	65	4xM6		F05
32	4,5		6		9				38	29				50	65	4xM6		F05
40	5		8		11				49	38				70	100	4xM8		F07
50	5		8		11				50	36				70	100	4xM8		F07
Toler.					-0.1													

65	5,5	13	11	2	14	M12			69	56			55	70	88	4xM8		F07
80	5,5	13	11	2	14	M12			75	59			55	70	88	4xM8		F07
100	2	12	11	6	16	M12			114	99			55	70	88	4xM8		F07
125	19		11	4	20				112	93			70	102	125	4xM10		F10
150	19		11	4	20				118	93			70	102	125	4xM10		F10
Toler.					-0.1													

200	65						35	20	92	65	38	10	85	125	149	4xM12	A-10x8 - 63	F12
250	79						40	20	108	67	43	12	100	140	179	4xM16	A-12x8 - 80	F14
300	88						50	20	133	67	53.5	14	130	165	209	4xM20	A-14x9 - 90	F16
350	80						50	20	192	116	53.5	14	130	165	209	4xM20	A-14x9 - 80	F16
400	110						70	25	242	141	74.5	20	200	254	300	8xM16	A-20x12 - 100	F25
500	115						90	40	259	183	95	25	230	298	350	8xM20	A-25x14 - 100	F30
600	115						90	40	274	173	95	25	230	298	350	8xM20	A-25x14 - 100	F30
700	167						100	40	336	210	105	28	260	356	415	8xM30	A-28x16 - 160	F35
800	167						120	40	365	210	127	32	260	356	415	8xM30	A-32x18 - 160	F35
Toler.					-0.1													

# Coupling dimensions, full bore ball valves DN 10–800 with actuators

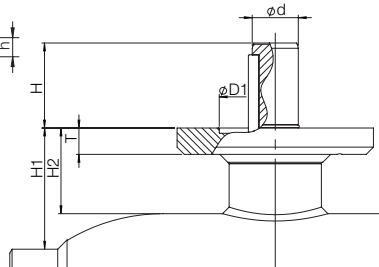
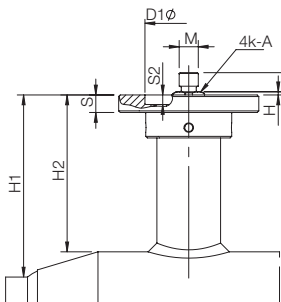
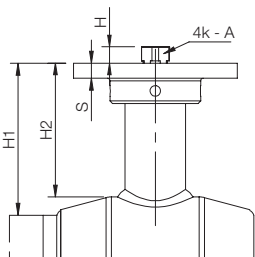
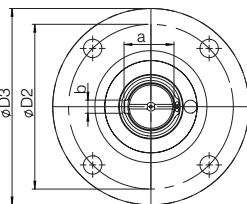
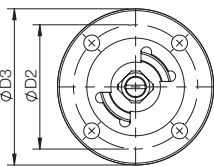
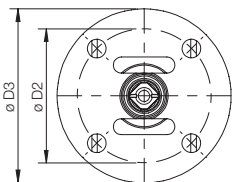

DN 10–40  
DN 100–125

DN 50–80

DN 150–800

DN	H	h	S	S2	A	M	Ød	T	H1	H2	a	b	D1	D2	D3	Bolts	Key	Flange ISO5211
15	4,5		6		7				31	21				50	64	4xM6		F05
20	4,5		6		9				43	32				50	65	4xM6		F05
25	4,5		6		9				43	29				50	65	4xM6		F05
32	5		8		11				52	38				70	100	4xM8		F07
40	5		8		11				56	36				70	100	4xM8		F07
Toler.					-0.1													

50	5,5	13	11	2	14	M12			76	56			55	70	88	4xM8		F07
65	5,5	13	11	2	14	M12			81	59			55	70	88	4xM8		F07
80	2	12	11	6	16	M12			127	99			55	70	88	4xM8		F07
100	19		11	4	20				125	93			70	102	125	4xM10		F10
125	19		11	4	20				132	93			70	102	125	4xM10		F10
Toler.					-0.1													

150	65						35	20	118	65	38	10	85	125	149	4xM12	A-10x8 - 63	F12
200	79						40	20	135	67	43	12	100	140	179	4xM16	A-12x8 - 80	F14
250	88						50	20	158	67	53.5	14	130	165	209	4xM20	A-14x9 - 90	F16
300	80						50	20	208	116	53.5	14	130	165	209	4xM20	A-14x9 - 80	F16
350	110						70	25	267	141	74.5	20	200	254	300	8xM16	A-20x12 - 100	F25
400	115						90	40	309	183	95	25	230	298	350	8xM20	A-25x14 - 100	F30
500	115						90	40	325	173	95	25	230	298	350	8xM20	A-25x14 - 100	F30
600	167						100	40	387	210	105	28	260	356	415	8xM30	A-28x16 - 160	F35
700	167						120	40	417	210	127	32	260	356	415	8xM30	A-32x18 - 160	F35
800	220						140	40	449	210	148	36	325	406	475	8xM36	A-36x20 - 200	F40
Toler.							-0.1											