

SUMMIT 8800

Digital flow computer with graphic display

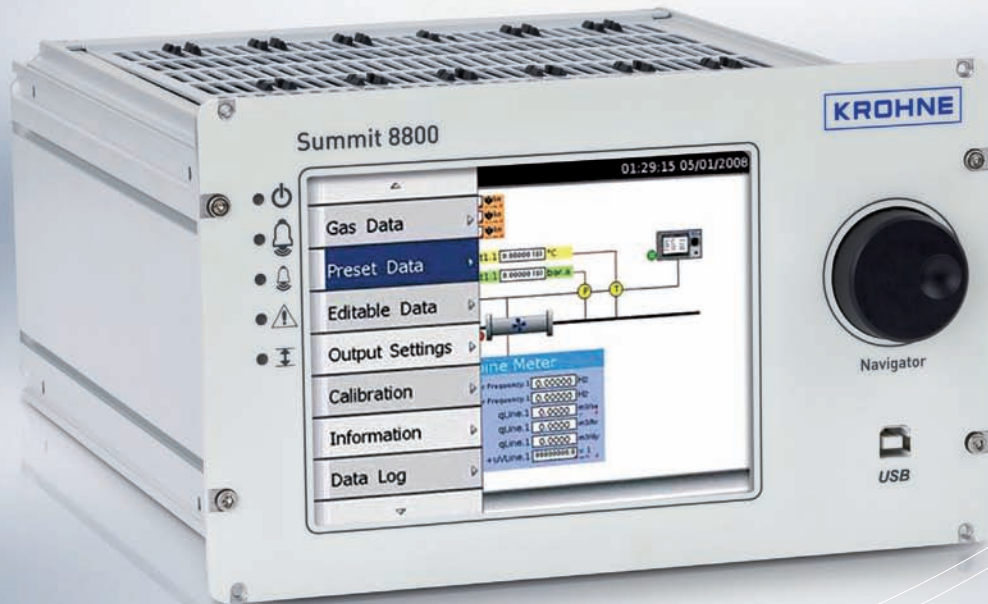

KROHNE

▶ *achieve more*

- ▶ Lower OPEX and CAPEX due to modern design and communication
- ▶ Low inventory cost with one computer fits all due to modularity of hard and software
- ▶ More effective maintenance and operator due to colour graphics touch screen
- ▶ Minimize service cost and automatic remote metering with unsurpassed network support
- ▶ Increased accuracy and reduce re-calibrations with automatic performance monitoring



Achieve more in Flow Computing

In 1982 we were one of the first companies to produce a micro-Processor-based flow computer. We have seen the technology become established, but there has been little change to the initial concepts.

"Create a flow computer that will increase performance, save time and be more cost effective and have the best possible accuracy!"

We took up the challenge, and the result is the new

Summit 8800.

Summit 8800 bring the flow computer into the communication age.

Handling:	Scroll & Click menu navigation Touch Screen operation Multicolour traffic-light guidance
Communication:	Fully redundant Ethernet LAN Local Area Network capability
Processing:	Dedicated processor per I/O board
Security	Multi-level access and authorization levels Full audit trail Separation of fiscal and maintenance data
Versatility:	4GB removable memory Plug-in boards for more streams, analysers, or communications
Accuracy	Fully digital, highly accurate analysis Fast processing with true 1/4 sec.
Wide use:	Any metering type Oil; Gas; Steam; Water

Putting brain power into flow computing.

“Create a flow computer that will increase performance, save time and be more cost effective!” Summit 8800, taking flow computing to new heights.



The current Digital Flow Computers have been around since the 1980's and are limited in their functionality and their human interface. Summit 8800 has overcome these limitations by utilising the tremendous advances in computers since then. You will experience optimization at all levels, including, of course HART, A/D, the speed of access, calculation and operation.

Navigator - the right way

The most obvious improvement is the operator interface. We chose a large colour graphics screen with touch sensitive screen. The operator now has a simultaneous overview of all the important measurements, parameters and alarms in easy-to-understand colour. The graphics also allow historical trends and even mimic displays.

Operation is as simple as pointing a finger or turning a dial. The user is guided through the menus and can select one by touching the screen, or with a scroll-and-click” of the Navigator dial. For data entry a numeric or typewriter style keyboard can be displayed on screen.



Power to spare

Hidden deeper in the computer are the true changes in the computing power. With its 32 bit processor, more than 64 Mbyte memory and 4 GB of disk space on its SD card the computer resembles a high powered PC. Moreover, a typical flow computer configuration has three of these processors. Fully loaded, seven of these processors handle up to 18 serial and 12 Ethernet network interfaces. So it is no surprise that we can safely guarantee that each of the 5 fiscal streams will be reliably measured every quarter of a second.

Configuration: Anything goes ...

Fiscal metering and allocation metering with one and the same flow computer

Most current flow computers have been designed for custody transfer applications. The result is that they are typically too slow and hardly economical for multiple allocation metering.

Our engineers decided that with current state of technology you can do better. They designed a computer that can handle up to 5 meters in one chassis and do all calculations within 1/4 second or better. Thanks to slot-in boards in a single chassis, Summit 8800 is very affordable. Now the same flow computer can handle fiscal and allocation applications, which makes engineering and maintenance easier.

Liquid, gas, steam

The Summit 8800 has been designed for any metering application including hydrocarbon liquids, dry natural gas, steam, industrial gases, water. Summit 8800 supports the most important measurement standards such as AGA, ISO and API.

Mix and match different meter types

Each flow computer can handle any meter type, such as turbine, Coriolis, PD orifice, venture and ultrasonic, or provers. For each individual stream the meter type and medium can be specified. So individual boards in a single flow computer can handle for instance an ultrasonic oil meter, a turbine water meter and an orifice gas meter.

Other functions

The Summit 8800 is not limited to metering only. All essential functions have been integrated:

- Flow computer redundancy
- Totalizing of several runs in or outgoing runs,
- Automatic proving including proving report
- Batching
- GC data distribution throughout a pipeline
- Run switching
- Flow proportional sampling
- Transmitter validation and calibration

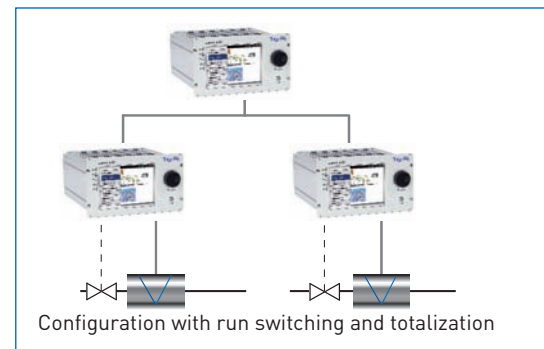
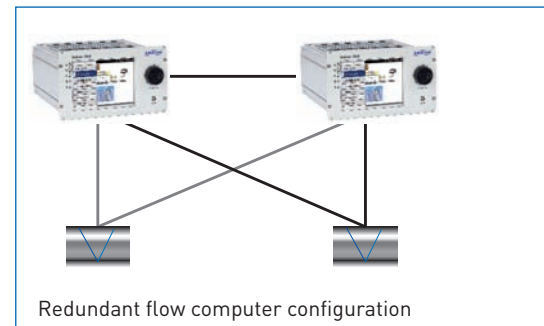
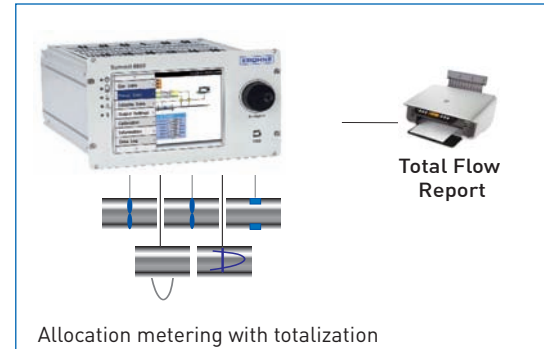

Networking flexibility leads to substantially lower maintenance costs

The new flexibility of networking

Networking and Ethernet communication has made life far easier. Now we can plug our computers, printers, copiers and even telephones in one and the same connector. The capabilities of flow computers lagged behind.

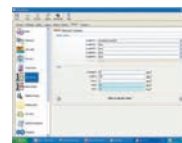

Our engineers have integrated state-of-the-art communication technology alongside more traditional communication methods. The Summit 8800 can handle a combination of several serial and Ethernet ports. Reports can be printed by a FTP network printer and even sent in an SMTP e-mail.

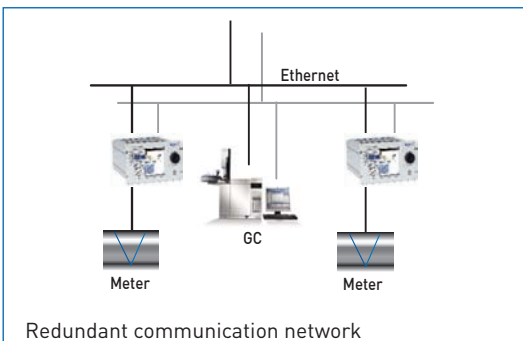
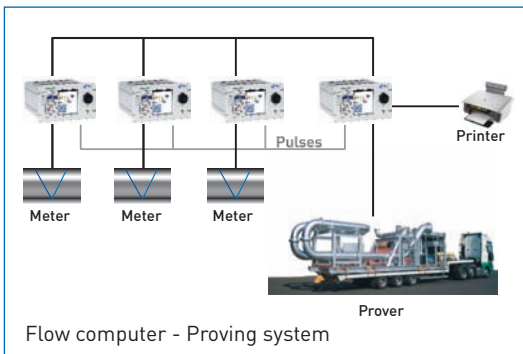
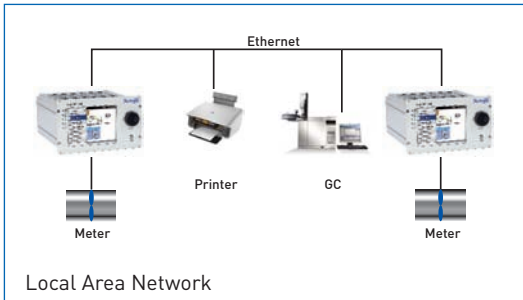

Local Area network

The preferred communication nowadays is TCP/IP which is standard for any Ethernet network. We added the security of multiple Ethernet ports to support redundancy and to separate the process from operation. Ethernet makes metering much simpler and safer to communicate with equipment such as supervisory systems, PLC, DCS, flow meters, chromatographs, printers, etc.

Flow computer - Prover system

Small flow computer-based systems, such as a proving system, can easily be created. Each flow computer can handle one stream, while a prover computer handles the automatic proving sequence, all within a network or in one housing

Redundancy

Because Summit 8800 has multiple Ethernet ports, there is no problem to create a redundant communication network, even when the flow meter also requires an Ethernet port. To guarantee security each port is completely independent from each other, so communication failure on one port will not affect another port.



Communication minimizes maintenance

Remote capabilities will make a difference when multiple stations are installed at different locations.

Remote monitoring - web enabled

Whether it's an FPSO out in the ocean, a shuttle tanker off- or on-loading, an oil rig offshore or a tank farm in the desert or a pipeline in the tundra. You are effectively there, whenever you wish.

Each Summit 8800 can have its own integrated web site. This lets you view all data on any chosen PC, laptop, tablet, or even a mobile phone, if security permits. And we've added a further security aspect by separating fiscal data from meter operation and maintenance data.

Weather, distance, schedules, personnel availability, visas - they no longer play a role. Your connection can be made secure, protected and validated.

Remote metering means instant billing

Immediate access to data now allows you to schedule billing with split-second accuracy.

Energy measurements through GC sharing

With the current importance being attached to energy versus volume, it would be ideal to install GC's throughout the pipeline ... but impractical. The optional Summit 8800 network allows you to transfer GC data from one flow computer to the other.

From your laptop you can access a website containing your Summit flow computer, simulating on your screen the data from your remote flow computer.

Modularity and expandability

Minimize inventory and upgrade costs

Only pay for the hardware you need

Most traditional flow computers won't grow with your needs. Their rigid design in hardware often means that different models are needed for single and multiple streams. When an extra run is needed, you are forced to replace the complete unit.

Summit 8800 in contrast has a modular design: just add the components required. The basic chassis has a colour graphic display and 6 slots for optional boards. Run boards and communication boards can be slotted in as needed, to cover a full range of a single fiscal stream up to 5 streams and a prover. Now the same hardware can be used for a wide range of applications.

Maintain calculation speed

In traditional designs, the calculation speed often dramatically decreases with increasing number of runs or additional communication.

In our design each card has its own processor, the processing power increases with each additional card. The calculation cycle can therefore easily be retained while the number of streams increases or when additional communication is needed. The Summit 8800 therefore has an impressive TRUE quarter of a second cycle.

Expand the memory

In traditional designs, the memory is limited and fixed. But the demand for memory has increased: the API requirement for 35 days of history, for example, is already a problem for several flow computers. The Summit 8800 has an internal memory of 64 MB and a removable SD card with enough Gbyte for a lifetime of data.

Future proof

During the last decade a lot of changes have occurred, not only in the meter types, but more markedly in the communication field.

Summit 8800 is designed for most of the current requirements, such as smart indexes and mobile communication. Software-reconfigurable hardware is used to enable new functionality. Plug-in boards are easy to add or exchange so the computer will not easily become obsolete.

The basic design for a single stream ...



... can be expanded inexpensively in minutes with plug-in boards

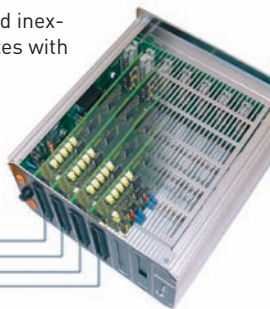

One flow computer for all applications Facilitate plant design

▶ *lower* Maintenance

Software options reduces engineering costs down to new level

Configuration has always been a compromise between ease of use and ultimate capabilities. Most computers only offer one choice: either menu driven with the limitation of pre-configured capabilities; or programming with the need for specialised personnel.

Summit 8800 is a chameleon offering the choices needed for any type of application.

Menu driven: quick and easy

Most people will simply select the menu driven approach or will start from it. For each stream the windows menu offers a choice of medium (liquid, gas, steam, etc.) and the meter type (e.g. ultrasonic, turbine, Coriolis, orifice, venturi, prover). Analysers are listed including GC's from most manufacturers. The menu guides you through selections, such as the sensors used, the type of correction, the communication, and allows you to customising the menu and the reports. It can also allow you to mimic the screen of other flow computers on your screen.

Local language menus and reports are possible. Communication can be adapted to match the host requirements.

The result can be sent via email and/or can be loaded into the flow computer within seconds using the fast USB port.

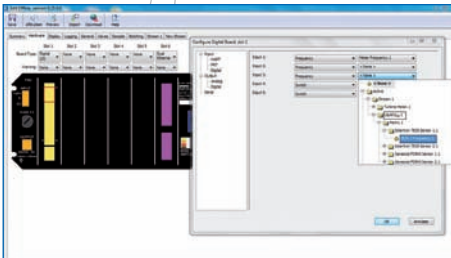

Specifications.

KROHNE Summit 8800	
Overview	
Number of streams	Up to 5 runs plus a prover
Calculation cycle	1/4 second max.
Communication	The Summit 8800 can handle a combination of several serial and Ethernet ports. Reports can be printed by a FTP network printer and even sent in an SMTP e-mail.
Audit trail/ logging	Full audit trail with person ID, Logging/ trending e.g. lifetime data, recorded 7 times per minute on 4 GB memory
Products	Oil, Gas, Liquids, Steam, LPG, LNG, industrial gases, Water, CO ₂ emission, etc.
Hardware	
Chassis	Half width 3U high 19" construction Panel or chassis mounted Dimensions 130 x 210 x 240 mm (h x w x d) Accommodates up to 6 I/O and communication boards IP20 Ingress protection index level IP52 in a panel with open doors IP 65 in an appropriately closed panel
Power supply	Supply voltage 22 to 28 V DC 8.5 W (15 W fully loaded) Protection 3.15 A fuse Auxiliary Outputs 24 V 200 mA
Operating	Operating Temperature -10...55 °C (15...130 °F) Storage Temperature -20...70 °C (0...160 °F) Operating Humidity to 90% non-condensing Weight approximately 2.0 kg / 4.5 lbs (2.5 kg / 5 lbs full loaded)
Rear Panel	
Field connections	PSU connections and fuse Six slots for option boards I/O and Communication Connections
Switch Panel	Access to Security Mode switches Access to Memory Card

Specifications

KROHNE Summit 8800	
Front Panel Display	
Display	5.7" Colour graphics screen Touch Panel 360° Rotary menu navigation Local Language Support 5 x High Brightness Indicator LED's Front Panel USB connection
Various	
Configuration	Menu-based configuration program Local Data Downloading via USB Local Diagnostics and ...and configuration setup
Connectors	RS232/485 RJ45 Ethernet 10/100 Mbs RJ45 Connector kit to rail mounted screw terminal I/O board Weidmüller non-screw type 36-way Part 1748640000 Power in Weidmüller connector Part 1606650000 Power out Weidmüller connector Part 1727560000
Meters and Standards	
Meter technology	Pulse: e.g. Turbine, PD, Prover, Ultrasonic, Coriolis DP: e.g. Orifice, Venturi, Cone, Nozzle Serial: e.g. Ultrasonic, Coriolis, Turbine / Rotary
Connectivity	Meters: Turbine, Coriolis, PD, Ultrasonic, Orifice, Venturi, Nozzle, etc. Ultrasonic meters: KROHNE, Daniel, Elster, GE, Sick, etc. Chromatographs: ABB, Daniel, Elster, Siemens, etc. Density/ specific gravity: frequencies Solartron 781x, 783x, Sarasota ID900 Provers: Bi-directional, 2 / 4 detector inputs, piston prover, master provers Control: up to 18 valves, Prover, PID
Approvals	Compliant with all international approvals, including - MID European approval - CSA C22.2, CB, CCSAus - UL 61010-1, IEC 61000-4, IEC 61010-1, EN G1326-1 - OIML R117 - NMI metrology requirement

Specifications

KROHNE Summit 8800	
Meters and Standards (cont.)	
Standards	Compliant with international standards, including ·ISO 5167 (1991, 1997, 2003), ISO 6976, ISO 6578 ·PTZ, NX19, NX19 G9, SGERG ·AGA3, AGA5, AGA7, AGA8, AGA9, AGA10 ·API MPMS 11.1, 11.2, 21 (1952, 1980, 2004) ·API Chapters 12.2.5.1, 12.2.5.2, 12.2.5.3 ·ASTM D1250 IP200 ·OIML R022 ·GPA 2172 ·GPA TP-15, TP-25, TP-27 ·GOST NX19
Processing	Calibration up to 30 points linear (positive or negative), meter factor or K-curve, 5 products Pulse handling: API5.5 level A, B, C, D, E, Dual chronometry, pulse interpolation Counters: Unhalttable, Normal, Period, Error, Maintenance, Positive and negative, Prover Averages: Time weighted, Flow weighted
Redundancy	
Master/Slave computer	Health based switching Built in redundancy system Duty-standby system based on health indicator Healthiest computer Duty Other flow computer Hot standby Health watchdog system

Specifications

	KROHNE Summit 8800				
I/O Boards	Type Board:	Digital 1	Digital 2	Analog	Switch
HART transmitter loop	Up to 3 transmitters (if multi-dropped) Up to 4 variables per transmitter For temperature, (differential) pressure, meters	2	2	1	-
Direct PRT Input	3 or 4 wire PT100 temperature input -20°C ... + 100°C (10 ... 210°F), 100 W, 1 mA energise	1	-	1	-
Analog Inputs	4-20 mA, 100 ohm, 20 bit resolution, accuracy 0.01 % FS @ 20 °C 3 standard, 1 optional (instead of 1 Digital output) Selectable: either additional 1x 4-20 mA input Selectable: either 1x 4-20 mA output or 1x Digital Output	-	-	3 / 4*	-
Digital Inputs for Switch / Valve / Status 3 of which can be: Pulse Counting/ Frequency Inputs	Optically isolated, 24 Vdc, 25 mA DC to 10 kHz, optically isolated ISO 6551 or API Chapter 5.5 Level A, B-E Turbine, density, status or detector switch max, Input voltage + 24 Vdc or 1.2 Vdc	5 (3)	4 (3)	5 / 4* (3)	6 (3)
Digital / Switch / Valve / Alarm / Pulse Outputs	Open Collector, 30 V max, 20 mA, 100 mW Frequency 2, 5, 10, 25, 50 Hz @ 50% duty cycle	5	6	5 / 4*	6
Analog Outputs	2 standard, 1 optional (instead of 1 Digital output) 4-20 mA, loop max. 750 W, 26 mA 16 bit max error 0.15% For telemetry and PID control	2	4	2 / 3*	
Selectable Digital Input or Output	Can be individually selected to be input or output Same specifications as above	-	-	-	6
Serial Communication Connection	RS232/RS485 Speeds up to 38400 baud, software handshake Modbus Master/Slave communication For meters (ultrasonic, Coriolis), GC and analysers	1	1	1	1

* 1 input and 1 output selectable to be digital or analog

Specifications

KROHNE Summit 8800			
Communications Boards	Type Board:	Single Ethernet	Dual Ethernet
Serial Communication Connection	RS232/ RS485 Galvanically isolated, Port 3: hardware handshake (RTS/CTS); Port 4/5 Software handshake Speeds up to 38400 baud RJ45 Connector Fully user configurable Modbus For DCS, Scada, GC, serial printers or RTU	3	3
Ethernet Port	10/100 MHz RJ45 port with indicators IEEE 802.3 Fully use configurable and programmable - Applications e.g.Modbus master and slave over TCP - Remote diagnostics and configuration - Web Server functions- Network Time Protocol	1	2
Capabilities	Provides a redundant network Separate fiscal from maintenance data SOAP communication protocol Secure data transfer Encrypting of data	no	yes

* 1 input and 1 output selectable to be digital or analog

**Polymer coating is optional:

Special coating to withstand moisture and salty mist as need to comply with OIML D11 class H2 (standard unit complies to class H1)

Specifications

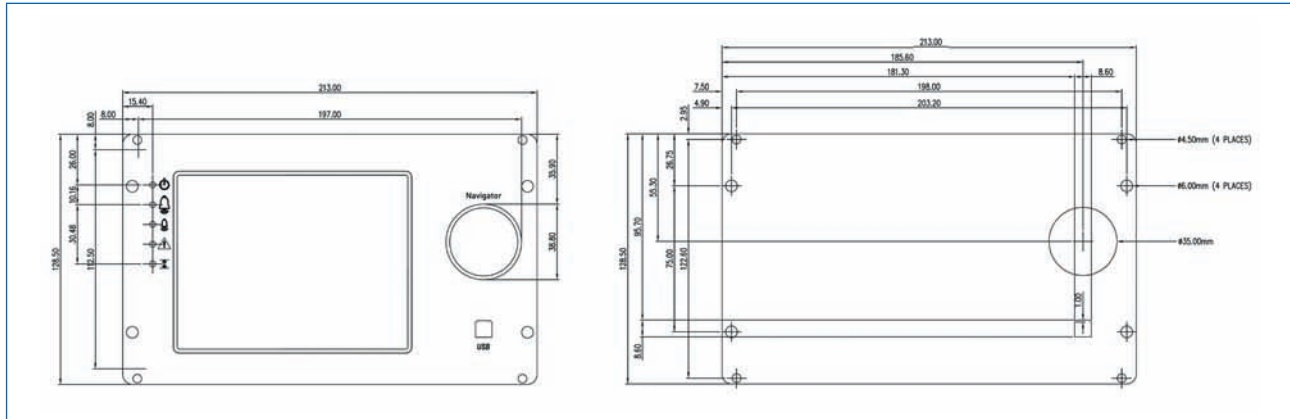

Dimensions [mm]

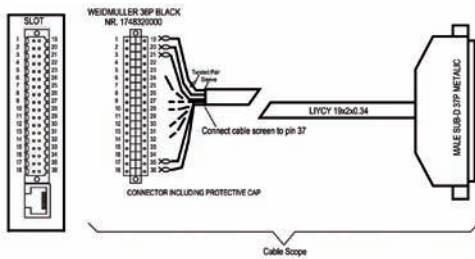

Cable connection diagram



Cable assembly, 2.5 m and rail-mounted terminal

Ordering options

Up to 6 slots with free choice of:

- A: Analogue I/O board
- H: HART I/O board 1
- K: HART I/O board 2
- S: Switch board
- E: Communication board: single Ethernet
- D: Dual Ethernet board: dual Ethernet

P: Polymer-coated to withstand moisture and salty mist, complies to OIML D11

O: No cables

C: Cable assembly (2.5 m) for each I/O board

O-No training

1: 1 day operator training at KOG

2: 2 days engineering training at KOG

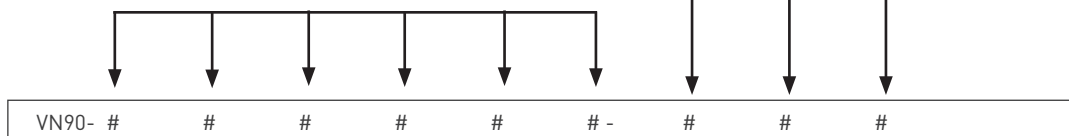

Notes

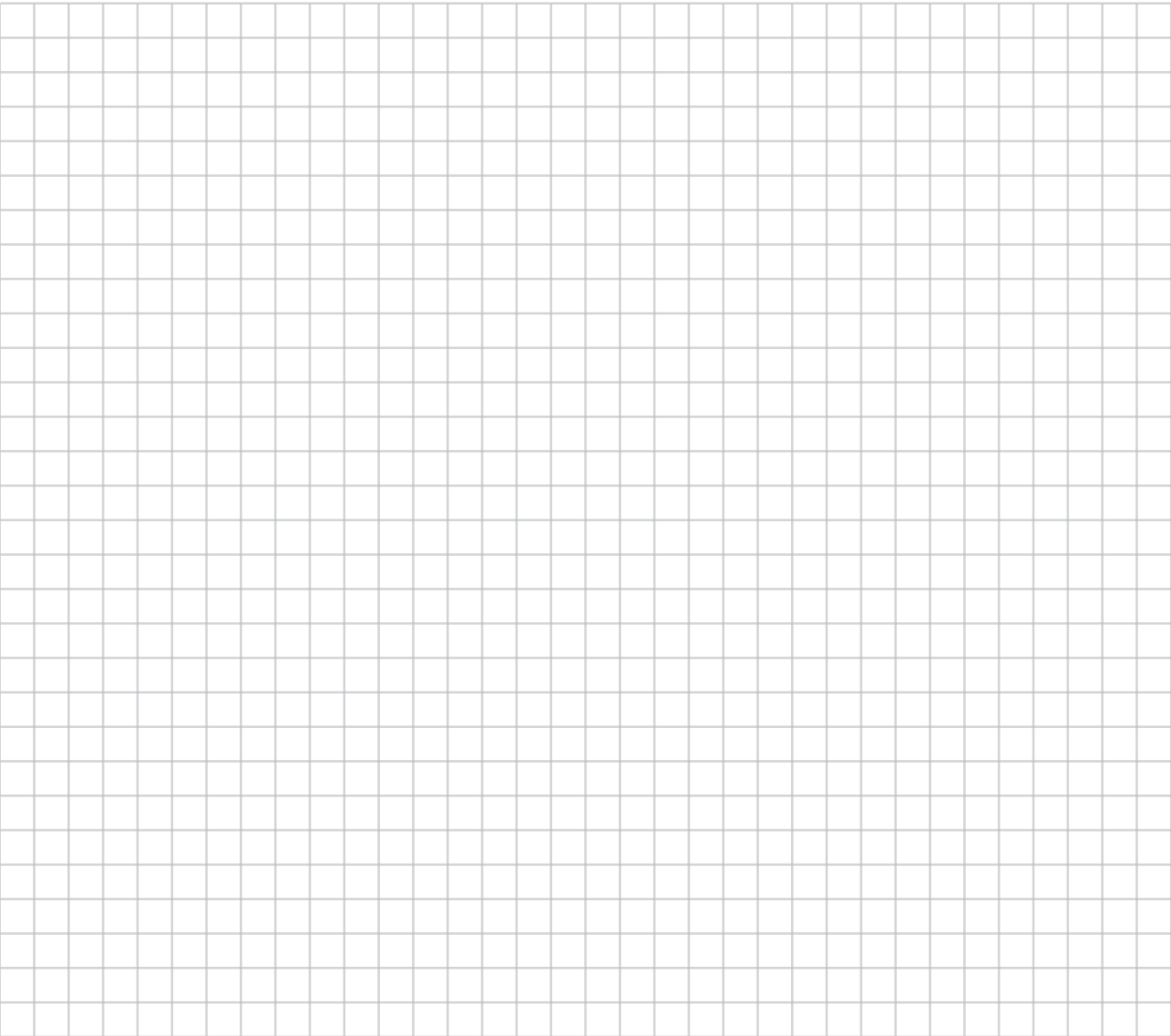

KROHNE Oil & Gas Overview

Systems

- Flowmeters for custody transfer
- Liquid flowmetering systems
- Gas flowmetering systems
- Wet gas metering systems
- Provers & master meters
- Flow computing, supervisory software & analyzer management
- Calibration systems
- Tank inventory & management systems
- Analyzer houses and shelters
- Loading & off-loading systems
- Leak detection and localisation systems
- Revamps & upgrades
- Testing, installation, commissioning, service training

Products

- Gas ultrasonic flowmeters for custody transfer
- Liquid ultrasonic flowmeters for custody transfer
- Mass flowmeters for custody transfer
- Venturis for wet gas metering
- Prover sphere detectors
- Flow computers
- Supervisory systems
- Meter validation software packages
- Electromagnetic flowmeters
- Level measuring instruments
- Variable area flowmeters
- Temperature measuring instruments
- Pressure measuring instruments
- Analyzers
- Vortex flowmeters
- Flow controllers

Contact

Head office KROHNE Oil & Gas
KROHNE Oil & Gas B.V.
Minervum 7441
4817 ZG Breda
The Netherlands
Tel.: +31 76 711 200 0
Fax: +31 76 711 200 1
koginfo@krohne.com

KROHNE (Malaysia) Sdn Bhd
No.F2, Block 46, Mentari Business Park,
Jalan PJS 8/2, Bandar Sunway,
46150 Petaling Jaya, Selangor, Malaysia
Tel.:+ 603 5636 8286
Fax:+ 603 5636 8366
koginfo@krohne.com

KROHNE Australia Pty Ltd.
5 Phiney Place
Ingleburn NSW 2565
Tel.: +61 2 9426 1700
Fax: +61 2 9426 1755
krohne@krohne.com.au

Global companies and representatives
see www.krohne.com



www.krohne.com